

# Optimization of excess system capability for increased evolvability

J. D. Watson<sup>1</sup> · J. D. Allen<sup>1</sup> · C. A. Mattson<sup>1</sup> · S. M. Ferguson<sup>2</sup>

Received: 19 December 2014 / Revised: 26 September 2015 / Accepted: 20 October 2015 / Published online: 9 January 2016  
© Springer-Verlag Berlin Heidelberg 2016

**Abstract** System evolvability is vital to the longevity of large-scale complex engineered systems. The need for evolvability in complex systems is a result of their long service lives, rapid advances to their integrated technologies, unforeseen operating conditions, and emerging system requirements. Building excess capability into complex systems can improve their ability to evolve while in service. However, excess capability increases initial build cost and operating cost, which is compounded across the service life of the system. Excess capability that is eventually used adds benefit by allowing for in-service evolution to meet emerging system requirements. Therefore, there is a trade-off between the cost of excess capability initially built into the system and the benefit that is added to the system by enabling future evolution. This paper introduces a process for optimizing the amount of excess capability in a complex system. This process results in a set of evolvable systems without excessive cost. We demonstrate how this process can be used to select the amount of excess capability that should be included in a military ground vehicle.

**Keywords** Evolvability · Reconfigurability · Flexibility · Excess · Complex systems · Multi-objective optimization

## Nomenclature

$D_o$	Capabilities to meet current requirements
$D_f$	Capabilities to meet future requirements
$X$	Excess capability allotted for evolution
$b_i$	Benefit of excess capability for the $i$ -th future requirement
$c_i$	Cost of excess capability for the $i$ -th future requirement
$B$	Total benefit that is added to the system
$C$	Total cost that is added to the system
$V$	Total value that is added to the system
$E$	Measure of system evolvability
$Y$	Years of expected service life
$n$	Number of future system requirements

## 1 Introduction

Large-scale complex engineered systems (hereafter referred to as complex systems) are being developed with increasing frequency (Ferguson et al. 2007). Examples of complex systems are found in aerospace, naval, and power generation systems. They are characterized by complex interactions between sub-systems, long service lives, and large development and production costs (Bartolomei et al. 2012; English et al. 2001). The complex systems design process is largely cooperative across multiple disciplines (Lewis and Collopy 2012). Often, the associated decision-making body is so large that design and production decisions are delayed (Bloebaum and McGowan 2012), slowing completion and increasing total cost (Simpson and Martins 2011).

The cost and time associated with complex systems development is in part due to an uncertainty in future system requirements. Their long service lives often necessitate

---

✉ C. A. Mattson  
mattson@byu.edu

<sup>1</sup> Department of Mechanical Engineering,  
Brigham Young University, Provo, UT 84602, USA

<sup>1</sup> Department of Mechanical and Aerospace Engineering,  
North Carolina State University, Raleigh, NC 27695, USA

changes to operating conditions and requirements that are unforeseeable during design (Madni and Epstein 2011). The impact of these changes must be accounted for when making design decisions. Bonissone et al. note that with new complex systems there is often a lack of long-term data to corroborate predictions of future performance or evaluate the system's ability to handle emerging requirements (Bonissone et al. 2005). The effects of a single change can propagate throughout the entire system (Clarkson et al. 2004), making it difficult to predict the impact of emerging requirements on the system (VanBeek and Tomiyama 2012).

Evolvable systems have been a topic of increasing interest as a solution to this problem (Siddiqi and de Weck 2008). System evolvability is a measure of how well a system is able to adapt to meet new system requirements (Ferguson and Lewis 2006). Complex systems that are able to evolve to meet new system requirements have more long-term value than those that are not (Bloebaum and McGowan 2012). Quantifiable metrics are necessary for optimizing complex systems for evolvability (Simpson and Martins 2011). Some metrics have been proposed such as system viability (Sandborn et al. 2003) and interface dependency (Tilstra et al. 2009). Modular design has also been studied extensively as a means for improving flexibility and evolvability. Sosa et al. suggest a metric that defines modularity based on connectivity of components (Sosa et al. 2007).

Excess capability often accompanies modular designs (Ulrich 1995). The amount of excess capability in a system can serve as a quantifiable metric for system evolvability. Tackett et al. suggest that intentionally built-in excess capability increases the evolvability of complex systems (Tackett et al. 2014). Allen et al. show that this is true as long as the capability is of the appropriate type, quantity, form, and location required to meet a particular future need (Allen et al. 2014). Despite the benefits of excess capability, excess also increases the production and operating costs of the system. This trade-off between cost and benefit of excess capability must be accounted for when evaluating system designs.

Due to the enormity of complex systems, selecting the amount of excess capability to be included can be more easily managed through optimization. While the most effective optimization algorithm is generally problem specific, this paper will use a genetic algorithm to explore the design space. Genetic algorithms, though computationally expensive, are beneficial in that they are able to handle discontinuous objective functions commonly encountered in complex systems (Marler and Arora 2004).

This paper is built on the basic theories developed by Tackett et al. (2014), but takes an important step beyond their work. We present a framework for optimizing the amount of excess capability that should be included in a system based on the value that is added by the excess for

future evolution. The *value of evolvability* is introduced as a more useful measure to consider than *evolvability* when deciding how much excess capability to design into a system up front.

The analysis in this paper addresses both deterministic and non-deterministic conditions. To facilitate understanding, we first present the theory and example assuming deterministic knowledge. This is done in Sections 2 and 3. This theory is then expanded to the more complex scenario accounting for non-deterministic conditions. Sections 4 and 5 present the non-deterministic theory and example, respectively. For both the deterministic and the non-deterministic example, the optimization of a simplified military ground vehicle is considered.

## 2 Theory development (deterministic)

There is a trade-off between the costs of excess capability initially built into complex systems and the benefits of excess capability used to evolve the system. This trade-off can be optimized using the framework set out in Fig. 1. As shown, the framework breaks the system design into current requirements and potential future requirements. The benefit and cost for each future requirement are used to compute the total value of adding excess capability to different system functions. A process for formulating the benefit and cost relationships is given in Sections 2.3 and 2.4. An optimization routine is then used to select the optimal amount of excess capability resulting in a set of evolvable designs without excessive cost.

### 2.1 Future design requirements

Anticipating the emergence of potential future requirements is one of the main challenges of designing complex systems (Lewis and Mattson 2013). However, designers can identify potentially impactful requirements changes in complex systems using change modes and effects analysis (CMEA) (Keese et al. 2006). CMEA assists designers in evaluating the causes and effects of potential requirements changes. CMEA is most effective when combined with existing knowledge about trends and system-specific information. Unfortunately this information is often limited for complex systems. For the purposes of our analysis, we will assume that the most impactful future requirements for a complex system can be predicted by informed designers using CMEA or similar methods. The reliance on this assumption alone is insufficient; the non-deterministic aspects of future requirements must also be considered. To that end, this paper presents an approach to handle uncertainties based on estimates of the probability of occurrence of future events (see Section 4).

Once future requirements are identified, they can be broken down into a description of the capabilities needed to fulfill each requirement. These capabilities ( $D_f$ ) are inputs into our optimization framework, as shown in Fig. 1.

The capabilities needed to fulfill current requirements ( $D_o$ ) are also inputs into the framework. As described below, the currently required capabilities will act as a lower bound on the system design.

### 2.2 Excess capability

In order for systems to evolve, they must have the capability to support future requirements. In the case that future requirements are more demanding of the system than current requirements, excess capability is designed into the system initially to later be used in an evolved state. The amount of excess capability ( $X$ ) is dictated by the current and future design requirements according to:

$$X = D_f - D_o \tag{1}$$

where  $D_f$  is the capability required to meet predicted future needs and  $D_o$  is the capability required to meet currently known needs. The capabilities identified in the previous section feed into this step (see Fig. 1).

The amount of capability that can be allotted for a future requirement ( $D_f$ ) is not always a constant. Often there is a capability range that could satisfy the future requirement with varying benefit. Accordingly, excess capability allotted for a given potential requirement has a specific beneficial range. For the  $i$ -th requirement, this range is dictated by:

$$X_{i \min} \leq X_i \leq X_{i \max} \tag{2}$$

where  $X_{i \min}$  is the minimum amount of excess capability that can be allotted to fulfill the  $i$ -th new requirement, and  $X_{i \max}$  is the maximum beneficial amount of excess capability that can be allotted for the  $i$ -th new requirement. The variable  $X_i$  falls in the range of values that the excess capability is allowed to occupy in order to fulfill the  $i$ -th new

requirement and add benefit to the system. Excess capability allotted below  $X_{i \min}$  has a benefit of zero and no additional benefit above  $X_{i \max}$ , as illustrated in Fig. 2.

An example of the range of excess capability is found when considering how much excess to add for a future heating system in the cargo bay of an aircraft. There are multiple heaters that could be installed to meet this new requirement, each of which have different spatial and electrical demands. To satisfy this requirement, excess space and electrical capability could be built into the cargo bay. Excess power or space included less than the smallest available heater adds no benefit to the system because it does not allow for the addition of a heater. Any power or space included above the amount required by the largest candidate heater would add no further value towards meeting this need. Between these two values, excess capability results in a varying level of benefit.

Some components can operate across an entire range of performance in order to satisfy future needs. Such variable-performance components are able to dynamically adjust their parameters between  $X_{i \min}$  and  $X_{i \max}$ . For example, some military-contracted vehicle manufacturers have begun to use damping systems filled with magneto-rheological fluid (Tao 2011). These systems can actively change the damping coefficient of the suspension by application of a magnetic field. Used in parallel with external sensors, such damping systems are able to satisfy a range of damping needs to accommodate terrain changes. Such variable-performance components have built-in excess which allows them to evolve as requirements change.

### 2.3 Benefit as a function of excess

The benefits of excess capability are a result of having sufficient capability to support a future evolution, as shown in Fig. 2.

The benefit function is specific to the requirement it describes. Generally, it represents the monetary amount that will be saved by adding the excess capability into the

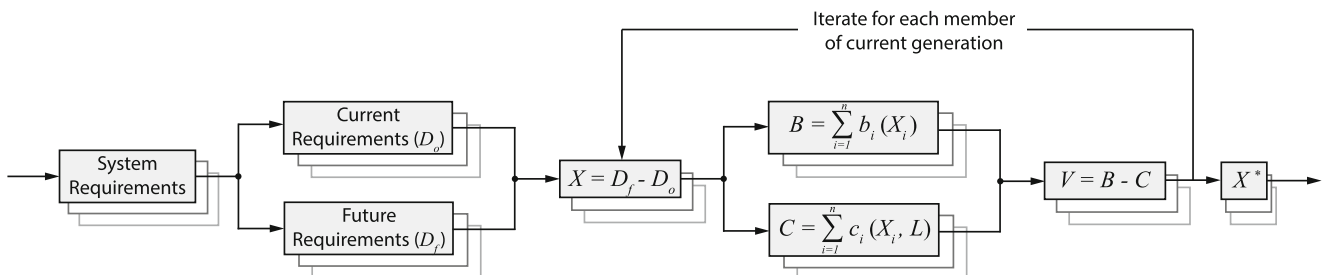

**Fig. 1** Framework for optimizing the amount of excess capability in a system ( $D_o$  = capability required for current requirement,  $D_f$  = capability required for future requirement,  $X$  = excess capability,  $b_i$  =

benefit of excess capability for the  $i$ -th requirement,  $c$  = cost of excess capability for the  $i$ -th requirement,  $B$  = total benefit,  $C$  = total cost,  $V$  = total value, and  $X^*$  = optimal amount of excess capability)

system initially, instead of redesigning the system when the new requirements take effect. However, the benefit can also include the economic impact from any emotional or social effects of being able to evolve to meet the new requirement.

Tackett et al. (2014) suggest steps for developing the benefit functions based on the minimum and maximum range of excess. Due to the time value of money, the benefit is dependent on when the requirement emerges during the system’s service life. This effect is described further in Section 2.5.

The total benefit of excess capability can be evaluated by summing the individual benefits gained from all  $n$  potential requirements, according to

$$B = \sum_{i=1}^n b_i(X_i) \tag{3}$$

As shown in Fig. 1, the total benefit is calculated for each iteration of the optimization, depending on the amount of excess ( $X_i$ ) allotted.

### 2.4 Cost as a function of excess

In their calculation of evolvability, Tackett et al. (2014) impose a constraint that requires the benefits of evolvability to be greater than or equal to zero. This implies that adding more excess capability can never cause evolvability to be negative. Although more excess capability may not decrease evolvability, at some point it may have a net negative impact on the system’s value, despite any benefits of being able to evolve. We therefore introduce a new variable ( $c_i$ ) to account for the cost of excess capability with respect to the  $i$ -th future requirement. The cost of excess capability is the sum of the initial and recurring costs of the added excess capability, and can be evaluated by

$$c_i = c_{io}(X_i) + c_{ir}(X_i, Y) \tag{4}$$

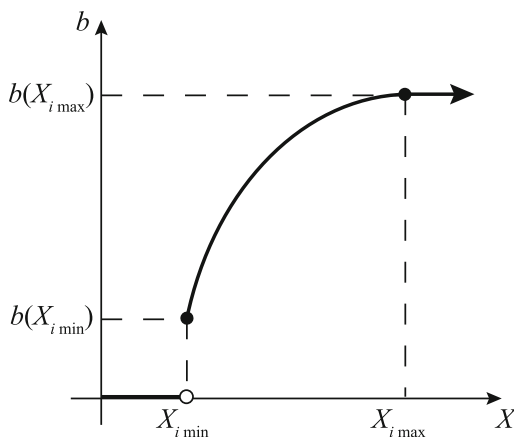

Fig. 2 Basic illustration of benefit as a function of excess capability

where  $c_{io}$  is the initial development and production cost of the added excess capability, and  $c_{ir}$  is the recurring operating cost of maintaining and supporting the excess capability across the expected service life ( $Y$ ) of the system. The recurring costs of excess become increasingly impactful with increased expected service life. However, the change in the initial costs of excess capability can decrease as more excess is added. This is the case where the initial production cost of adding  $X_{i\ min}$  is significant (e.g. due to tooling), but where adding slightly more excess above  $X_{i\ min}$  results in only a small increase in the initial production cost. This effect is illustrated in Fig. 3.

The total cost of excess capability can be evaluated by summing the individual costs of all excess added, according to

$$C = \sum_{i=1}^n c_i(X_i, Y) = \sum_{i=1}^n (c_{io}(X_i) + c_{ir}(X_i, Y)) \tag{5}$$

The total cost ( $C$ ) is thus the dollar amount incurred by adding excess capability initially and maintaining it before and after it is utilized. Like the total benefit, the total cost is calculated for each iteration of the optimization, as shown in Fig. 1.

### 2.5 Total value of excess capability

It is important for designers to be able to evaluate whether adding excess capability into a system will be worthwhile across the lifespan of the system. This can be accomplished by computing the difference between the benefits of excess capability and its associated costs, as in

$$V = B - C \tag{6}$$

We will refer to this difference as the value ( $V$ ) of the excess capability associated with allotting excess for all  $i$  potential requirements.

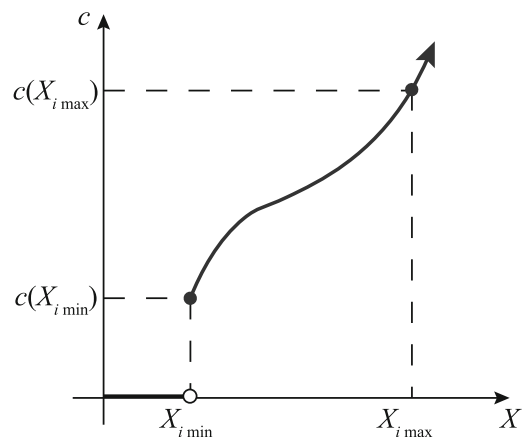

Fig. 3 Basic illustration of cost as a function of excess capability

Even a small amount of excess can increase the production and operating costs of the system. However, the benefits of excess capability are not realized until there is sufficient excess to enable future evolutions. Therefore, the value that is added by excess is typically negative for excess added below  $X_{i \min}$ . For clarification, these characteristics of the cost-benefit and value-excess curves are illustrated in Fig. 4.

Due to the typically long service life of complex systems, it is important to account for the effect of time on the value of excess capability. Increased service life means that the costs of excess must be carried for a longer duration. It also means that the benefits of excess capability are more likely to be realized and may have a greater impact. In order to account for part of this effect, the net present value of all cash flows can be computed for a given service life (Cardin et al. 2007). The net present value for a series of  $m$  cash flows can be calculated by

$$NPV = \sum_{i=1}^m \frac{FV_i}{(1-r)^t} \tag{7}$$

where  $FV$  is the future value of the cash flow,  $r$  is the rate of inflation or interest, and  $t$  is the time until the cash flow occurs.

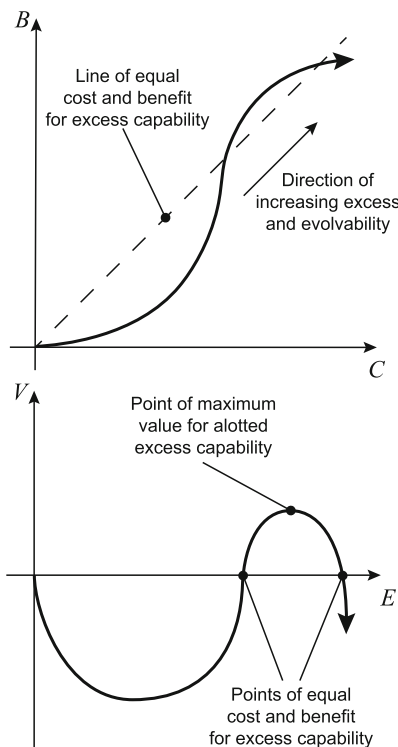

**Fig. 4** Illustration of how the benefits of excess can overcome the costs of excess

Including the net present value into our cost and benefit calculations results in a shift of the value curve from Fig. 4, dependent on the service life and cost and benefit functions specified by the designers. This shift is illustrated in Fig. 5.

**2.6 Optimization strategy**

The optimization seeks to maximize the benefits ( $B$ ) of excess capability, while minimizing any associated costs ( $C$ ). The evolvability of each solution is also calculated for comparison. Evolvability, as quantified by Tackett et al. (2014), can be measured based on the amount of excess capability in the system, according to

$$E = \sum_{i=1}^n \left[ \int_{X_{i \min}}^{X_i} g_i X_i dX_i \right] \tag{8}$$

This equation is based on Hooke’s law for the potential energy stored in a spring. The analogous relationship is that evolvability is stored in a system by the inclusion of excess capability. The gain ( $g_i$ ) in (8) allows designers to weigh the significance of including a particular type of excess capability. In the current study, the evolvability is normalized between the minimum and maximum possible evolvability score, eliminating the gain and producing a unit-less number

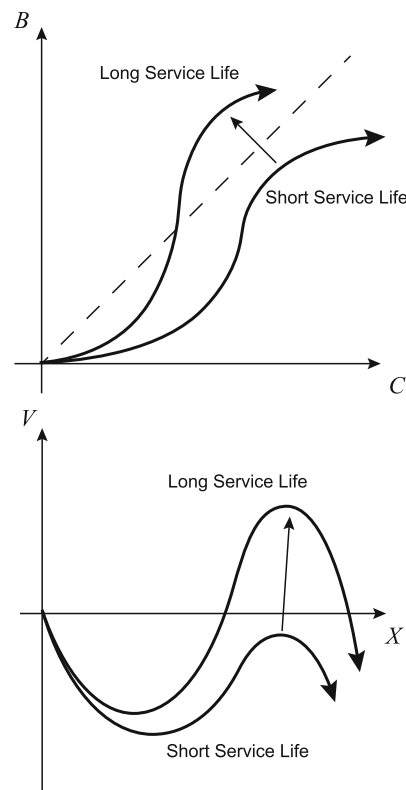

**Fig. 5** Illustration of shifting value curve due to increasing service life

between zero and one. This normalization allows designers to quickly evaluate the amount of excess that is contributing to the system's value.

In addition to this, most complex systems have their own problem-specific optimization objectives. The value functions developed in this paper are combined with any other critical performance objectives using the maximin fitness function. This function is often used in genetic algorithms to obtain a diverse set of non-dominated designs (Balling 2003). Constraints on the objectives should include minimum and maximum parameter values, as described in Section 2.2. Including the optimal amount of excess capability into the initial design allows the system to be evolvable within the bounds of profitability and functionality.

### 3 Example (deterministic): military ground vehicles

The described framework can be applied to the design of military ground vehicles (Fig. 6). In 2005, the US Marine Corps submitted requests for Mine Resistant Ambush Protected (MRAP) vehicles to replace their insufficiently protected fleet of High-Mobility Multipurpose Wheeled Vehicles (HMMWV) (Lamb et al. 2009). The request was spurred by an increase in improvised explosive devices (IEDs) – a new threat that the flat-bottomed, low-clearance HMMWV is not designed to address. However, despite urgent and repeated requests for MRAP replacements, it was several years before substantial shipments of MRAP vehicles made it to U.S. troops. Weiner (2010) cites evidence that the delay was caused by an inability to reconcile current needs for greater IED protection with predicted future needs for lighter, more maneuverable vehicles. Neither the HMMWV nor the MRAP were capable of being evolved to meet all potential requirements.

Ideally, military ground vehicles should meet a broad range of emerging needs. However, many of these needs

conflict with one another. For example, vehicle stability, top speed, and cargo capacity are all diminished by the addition of after-market armor added to increase protection. Even the benefits of additional armor are eventually countered by an increase in fuel consumption, and thus fuel convoy casualties (Hoffenson et al. 2011). Further, a given mission may elicit any combination of performance requirements.

The prevailing design approach for military ground vehicles has been to create several variations capable of performing well on a few limited mission types. This has led to delays and costly redesigns (Bloebaum et al. 2012). However, an optimal design can be prepared by identifying potential future requirements and adding excess capability accordingly.

By following the steps described in Section 2, we are able to select from a Pareto optimal set of military ground vehicle designs that are able to evolve to meet the predicted future requirements.

#### 3.1 Simplified vehicle model

Creating a simplified model of our complex system will assist in our analysis. Our model of a military ground vehicle is reduced to only consider a few areas of potential excess capability. The design variables of interest in this study are excess height ( $X_H$ ), excess width ( $X_W$ ), excess length ( $X_L$ ), excess payload ( $X_S$ ), and excess power ( $X_P$ ). The excess height, width, and length are used to compute the excess cargo volume of the system ( $X_V$ ). Accordingly, the construction of the vehicle is simplified to the diagram shown in Fig. 7.

For this example, the optimization routine is allowed to create solutions within a defined range of excess volume, excess payload, and excess power. The minimum and maximum allowable values for each design variable are given in Table 1. Note that each area of excess refers to the area in the back of the vehicle (shown by the dashed box in Fig. 7). However, the width of the vehicle ( $W$ ) and the width of the



**Fig. 6** Two current military ground vehicle options and their associated capabilities (from [www.amgeneral.com](http://www.amgeneral.com), [www.defense-update.com](http://www.defense-update.com), [www.militaryfactory.com](http://www.militaryfactory.com), [www.navistardefense.com](http://www.navistardefense.com))

excess volume ( $X_W$ ) are equivalent. The linear dimensions of the vehicle are not allowed to go to zero due to functional geometric constraints on the vehicle (see Fig. 7).

### 3.2 Future evolution requirements and associated excess capability

There are many new requirements that could arise across the lifespan of a military ground vehicle. For the purposes of this analysis, we assume that four such requirements are identified as being probable and impactful by a CMEA study. These future system requirements are listed in Table 2 with their accompanying types of required excess. Note that the example provided later in Section 5 includes probabilistic estimates regarding these future requirements.

The first predicted evolution allows the vehicle to become an armored transport vehicle capable of supporting an added armor kit and passengers. The required armor thickness is set to 50 mm, based loosely on the work of Hoffenson et al. (2011) and Yap (2012). In order for excess capability to benefit this evolution, there must be enough volume, payload capacity, and power to support the addition of armor and at least one individual. Benefit increases as a step function with the number of individuals that can be transported (see Table 3).

The second predicted evolution allows the vehicle to act as a telecommunications post for military operations. The vehicle must be able to power and support any equipment used for this purpose. Unlike the piece-wise step function used for modeling the benefit for transporting individuals, the benefit for this evolution has a linear growth beginning at the smallest amount of excess that can be allotted. This is to show that the vehicle can always make use of more excess capability to add more telecommunications equipment.

The third predicted evolution allows the vehicle to launch UAVs remotely. This evolution requires a minimum excess length of 3 meters, a minimum excess width of 2.5 meters, and a minimum excess payload of 100 kilograms. If the excess in the system is at least this amount, the full benefit of this evolution is realized. Otherwise, the system receives zero benefit with respect to this evolution.

The last predicted evolution allows the vehicle to support currently unknown medical-related technology that could be developed over the service life of the vehicle. The amount of excess required for such a need is approximated based on past technology trends. The benefit is determined by a distribution about the predicted need. As the excess capability in the vehicle approaches the predicted amount, the benefit grows exponentially.

### 3.3 Benefits and costs of excess

The benefit of excess is based on not needing to redesign for each future state described in Table 2. For the current analysis, we assume that the benefit of excess can be determined by designers who have been embedded in a particular industry for many years (either heuristically or based on known data points for similar systems and components). In our analysis, the benefits associated with each evolution are chosen according to Table 3.

The cost of excess is based on the actual amount of excess capability designed into the system. The costs of excess capability for the current analysis are given in Table 4.

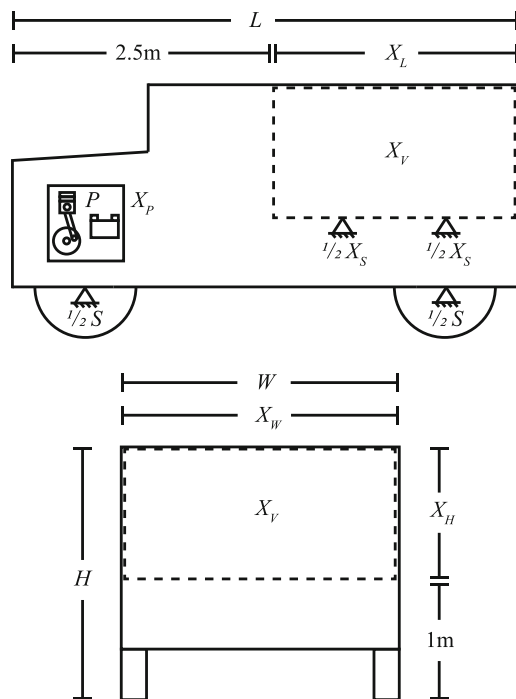

**Fig. 7** Simplified model of excess volume ( $X_V$ ), excess payload ( $X_S$ ) and excess power ( $X_P$ ) in a military ground vehicle

**Table 1** Minimum and maximum bounds on each type of excess capability

Type of excess	$X_{min}$	$X_{max}$
Excess length ( $X_L$ )	1.00 m	4.00 m
Excess width ( $X_W$ )	2.00 m	4.00 m
Excess height ( $X_H$ )	1.25 m	2.50 m
Excess payload ( $X_S$ )	0 kg	3000 kg
Excess power ( $X_P$ )	0 kW	400 kW

**Table 2** Potential future states to which the system may evolve (variables:  $n$  = quantity,  $V$  = volume,  $m$  = mass,  $\rho$  = density,  $A$  = area,  $t$  = armor thickness,  $P$  = power; subscripts:  $p$  = people,  $a$  =

armor,  $te$  = telecommunications equipment,  $u$  = UAV,  $le$  = launch equipment,  $md$  = medical devices)

Potential evolution	Excess volume	Excess payload	Excess power
Armored transport vehicle	$n_p V_p$	$n_p m_p + \rho_a A_p t_a$	$P_p + P_a$
Telecom vehicle	$V_{te}$	$m_{te}$	$P_{te}$
UAV launch vehicle	$V_u + V_{le}$	$m_u + m_{le}$	$P_u + P_{le}$
New medical tech vehicle	$V_{md}$	$m_{md}$	$P_{md}$

### 3.4 Deterministic optimization formulation

For clarification and comparison, we lay out the general parameters used in our genetic algorithm in Table 5. The first generation is randomly generated. Crossover is achieved using a standard blending function (Engelbrecht 2007).

The optimization seeks to maximize the benefits ( $B$ ) added by included excess capability, while minimizing any associated costs ( $C$ ). These objectives are aggregated using the maximin fitness function, which has been suggested as a means of creating a well-distributed Pareto set (Balling 2003). Thus, the formulation of the optimization problem is given as

$$\begin{aligned}
 & \underset{X}{\text{minimize}} && \text{maximin}(-B(X), C(X)) \\
 & \text{subject to} && 1.00 \text{ m} \leq X_L \leq 4.00 \text{ m} \\
 & && 2.00 \text{ m} \leq X_W \leq 4.00 \text{ m} \\
 & && 1.25 \text{ m} \leq X_H \leq 2.50 \text{ m} \\
 & && 0.00 \text{ kg} \leq X_S \leq 3000.00 \text{ kg} \\
 & && 0.00 \text{ kW} \leq X_P \leq 400.00 \text{ kW} \\
 & && 0.60 \leq \text{SSF}
 \end{aligned} \tag{9}$$

where  $X = \{X_L, X_W, X_H, X_S, X_P\}$ . The minimum and maximum bounds for each type of excess capability (see Table 1) form the primary inequality constraints. A final

**Table 3** Benefit of excess for each of the 4 potential evolutions in the military ground vehicle example

Benefit of excess ( $b_i$ )
$b_1 = \$30,000.00/\text{person} + \text{armor}$
$b_2 = \$50,000.00/\text{full support}$
$b_3 = \$10,000.00/\text{UAV}$
$b_4 = \$100,000.00/\text{approximate capability}$

inequality constraint ensures that the static stability factor (SSF) remains above 0.60 as defined by (10).

$$\text{SSF} = \frac{X_W}{2(X_H + 1)} \tag{10}$$

The static stability factor is a simple predictor of a vehicle’s propensity to roll (Walz 2005).

The described model is optimized following the formulation given by (9). The net present value of cash flows is calculated based on a set 5 % interest rate. Calculations are made based on a service life of 20 years. For these parameters, the optimal set of designs is found to be the set of solutions described by the cost-benefit Pareto frontier in Fig. 8. The value-evolvability curve is also shown for each point along the Pareto frontier.

### 3.5 Final design selection based on deterministic evaluation

We recognize that optimization techniques are meant to inform the designer, not to make the decisions for them (Pandey and Mourelatos 2014). Now that an optimal set of solutions has been generated, it can be used to make decisions regarding the trade-offs between competing objectives (Frischknecht et al. 2011). Selecting a final design can be accomplished by evaluating the optimal solution set based on any factors of interest to the stakeholders. In the

**Table 4** Costs for each excess capability in the military ground vehicle example

Initial cost of excess ( $c_{i0}$ )	Recurring cost of excess ( $c_{ir}$ )
$c_{Vi} = \$100.00/\text{m}^3$	$c_{Vr} = \$0.40/\text{m}^3/\text{year}$
$c_{Si} = \$7.00/\text{kg}$	$c_{Sr} = \$0.02/\text{kg}/\text{year}$
$c_{Pi} = \$50.00/\text{kW}$	$c_{Pr} = \$1.00/\text{kW}/\text{year}$



**Table 5** Genetic algorithm parameters and methods

Population size	500
Tournament size	50
Mutation rate	0.15
Generations	20

current analysis, one important evaluation criterion is the budget that will be allocated initially toward improving system longevity or evolvability. This budget is the maximum approved cost of all excess capability built into the system. Understanding the allowable budget will assist the design team in determining how much (if any) excess capability should be built into the system to support future evolution.

For example, if the expected service life of the system is 20 years, and a budget of \$40,000 is allocated for evolvability, then the red starred point shown in Fig. 9 is the optimal configuration.

This same process can be used for any budget or criteria that is measurable against the parameters of the optimization. Table 6 outlines the highest value configuration for

three different budget constraints, based on a 20 year service life.

According to Table 6, the optimal amount of excess length, width, and height are the same for each budget level shown. However, there is a significant difference in the optimal amount of excess payload capacity and power identified for each budget level. This suggests that adding excess payload and power in the range shown will provide a high return on investment.

The total value added by excess capability for each of these budget level solutions is positive. From Fig. 9 it can be seen that an initial budget of around \$35,000 is required to make excess capability profitable for this system. In short, if the stakeholders are not willing to invest this much into making the system evolvable up front, they should not design excess into the system.

If we assume that the stakeholders have allocated an initial budget of \$50,000 to be spent on improving system evolvability, we can extract the amount of excess that should be designed into the system. From Table 6 we find that the system that will yield the highest value for this budget, for a 20 year service life, is the system shown in Fig. 10.

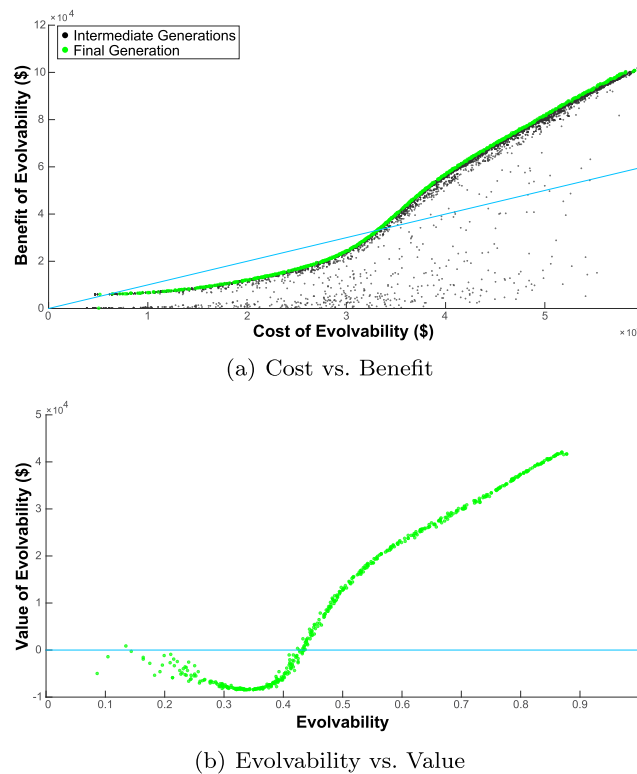

**Fig. 8** Preliminary generations and final solution set for military ground vehicle with a 20 year service life

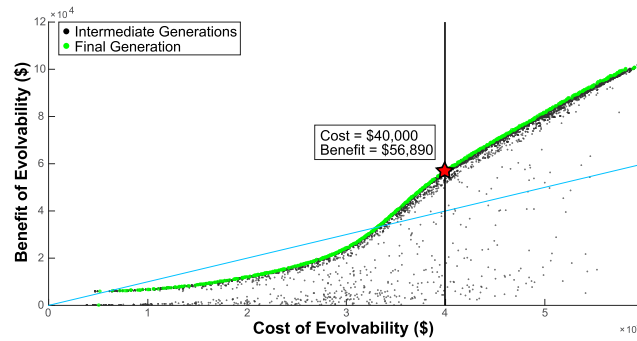

**Fig. 9** Optimal solution for a military ground vehicle with a 20 year service life and a \$40,000 budget constraint

The solutions recorded above are based on an expected service life of 20 years. As described in Section 2.5, the value of excess capability is a function of expected service life, and the value of a given quantity of excess capability was proposed to be higher for systems with a longer expected service life. To illustrate this, the cost-benefit and value-evolvability curves are plotted for 15 different service life expectations in Fig. 11. It is shown that the system must have a service life of at least 14 years in order for any amount of excess capability to be valuable.

General comments summarizing what is learned from both the deterministic and non-deterministic evaluation of the ground vehicle are provided in Section 6.

#### 4 Theory development (non-deterministic)

In the previous section, we presented a deterministic study demonstrating how the value of excess capability can be optimized with respect to evolvability. However, if not accounted for, uncertainty in future system requirements and parameters can result in an inaccurate representation of the design space and thus mislead the decision makers. The next two sections of the paper begin to explore this by

including uncertainty in the optimization process. We show that accounting for uncertainty can provide a more realistic solution for the optimal amount of excess capability than a deterministic optimization approach, particularly at the extremities of the design space. To demonstrate how we have done this, we revisit the design of a military ground vehicle.

The non-deterministic theory presented here is built on the premise that uncertainty in model parameters can be propagated through the system model and minimized in the optimization formulation (Ayyub and Klir 2006; Zhou et al. 2012; Parkinson et al. 1993). In Sections 4.1 through 4.5, we explore the effects of uncertainty in the following parameters and objectives: excess capability, probability of future events, benefit and cost of excess capability, net present

**Table 6** Highest value configuration for 3 different budget constraints

	\$40,000 Budget	\$50,000 Budget	\$60,000 Budget
$X_L$	3.98 m	3.97 m	3.97 m
$X_W$	3.91 m	3.90 m	3.90 m
$X_H$	2.22 m	2.24 m	2.24 m
$X_S$	1,999 kg	2,786 kg	2,946 kg
$X_P$	242.53 kW	288.93 kW	333.60 kW
Cost	\$39,870	\$49,872	\$54,887
Benefit	\$56,150	\$80,238	\$91,702
Value	\$16,280	\$30,366	\$36,814
Evolv.	0.52	0.71	0.81

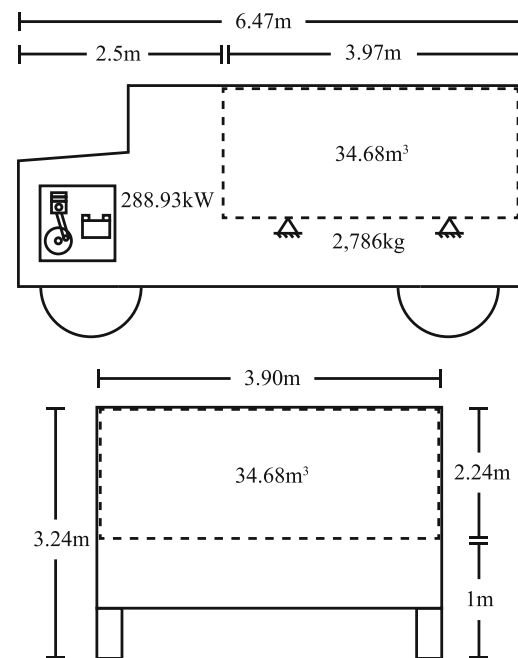

**Fig. 10** Simple representation of the final design for a military ground vehicle with a 20 year service life and a \$50,000 budget constraint

value of cash flows, and system evolvability. While there are multiple ways (some more effective than others) to represent uncertain parameters, and propagate them through the system model, we have presented the simplest of ways here so as to briefly and straightforwardly illustrate the effects of uncertainty on system evolvability.

### 4.1 Uncertainty in model parameters

The uncertainty associated with the physical parameters of the system is aleatory, meaning it is caused by random variation. The amount of excess capability in the system is affected by this type of uncertainty. Because the upper and lower limit for each capability form constraints in our optimization routine, the uncertainty in these parameters must be propagated through to the constraints. Accordingly, the range of excess capability defining the design space is limited to

$$(X_{i \min} + k\sigma_i) \leq X_i \leq (X_{i \max} - k\sigma_i) \tag{11}$$

where  $\sigma_i$  is the standard deviation of  $X_i$ , and  $k$  is the number of standard deviations within which solutions are considered feasible.

### 4.2 Uncertainty in future requirements

The uncertainty associated with future requirements is epistemic, meaning it results from a lack of information. However, historical knowledge of past and current requirements can be used to help predict future requirements with some degree of confidence (Arendt et al. 2012). Other methods, such as change modes and effects analysis (CMEA), can be used to evaluate potential requirements and their likelihood of occurrence (Keese et al. 2006). For the simple analysis presented in this section, we assume that it is possible for expert designers to assign each requirement a probability of occurrence within a certain life span, as well as a qualifying standard deviation for each probability. These assumptions are supported by and are in line with similar studies from the related literature (Greitzer and Ferryman 2001).

Often the probability that a future evolution will be required can be modeled with a normal cumulative distribution function with a predicted mean and standard deviation, as in Fig. 12. The example distribution shown in this figure has a predicted mean of 15 years before emergence of the future requirement, with a standard deviation of 4 years.

Figure 12 demonstrates how systems with longer expected service lives can benefit from excess capability more than those with short service lives. The effect of

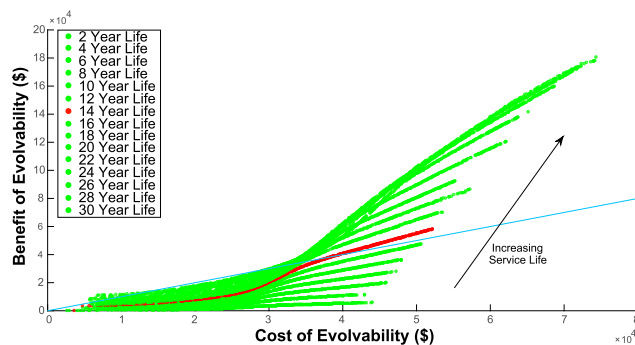

(a) Cost vs. Benefit

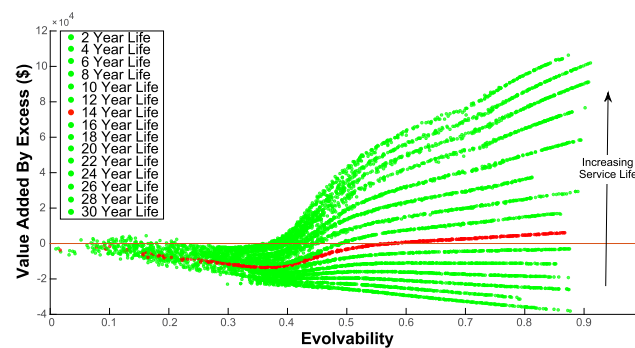

(b) Evolvability vs. Value

**Fig. 11** Minimum service life to create a net positive value of excess capability for the military ground vehicle example

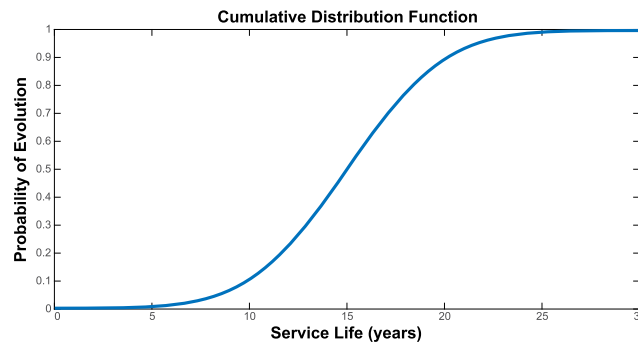

**Fig. 12** Example cumulative probability distribution with mean of 15 years and standard deviation of 4 years

probabilistic future requirements on the benefit of excess capability is discussed in Section 4.3.

#### 4.3 Uncertainty in benefit and cost

The benefits of excess capability are only realized if the predicted requirement emerges within the system's service life. Accordingly, the benefit of excess capability is calculated according to

$$B = \sum_{i=1}^{n_i} p_i b_i(X_i) \quad (12)$$

where  $p_i$  is the probability of occurrence of the  $i$ -th predicted requirement (as shown in Fig. 12), and  $b_i$  is the benefit that is added by  $X_i$  for that requirement.

The variance of the benefit can be calculated with the Taylor-series approximation according to

$$\sigma_B^2 \approx p^2 \sigma_b^2 + b^2 \sigma_p^2 + \sigma_b^2 \sigma_p^2 \quad (13)$$

where  $\sigma_b$  is calculated with the Taylor-series approximation from the variance of  $X$ . It should be noted that (13) assumes that all inputs are Gaussian and independent, which may be an inaccurate assumption in some practical cases. Nevertheless, we use it in this paper to simply indicate that propagating uncertainty is essential to the proposed theory and can be done with care using one of many propagation methods found in the literature (Ayyub and Klir 2006; Anderson and Mattson 2012).

The costs of excess capability are considered to be unaffected by uncertainty. This is because all initial costs are incurred immediately whether or not the predicted future requirement ever emerges. Any recurring costs are carried across the entire service life, even after the excess capability is used in an evolved state. However, because the recurring costs of excess are linked to the service life, the total cost will be greater for a system with a longer service life. Uncertainty in service life is discussed in Section 4.4.

#### 4.4 Uncertainty in service life

If there is uncertainty in the predicted service life of the system, it will affect the net present value calculated for all cash flows described in Section 4.3. We can account for this by including the probability of future events ( $p_i$ ) in the net present value (NPV) calculation according to

$$\text{NPV} = \sum_{i=1}^m \frac{\text{FV}_i}{(1-r)^{p_i t}} \quad (14)$$

where FV is the future value of the cash flow,  $r$  is the interest rate, and  $t$  is the time until the cash flow. Several methods have been proposed for dealing with uncertainty with respect to future cash flows (Cardin et al. 2007). The best method for accounting for this change depends on the information available during design. Engineers should use the method that works best with the information they have available.

#### 4.5 Uncertainty in evolvability

As defined by (8), evolvability is a function of the amount of excess capability in the system ( $X$ ). When we include uncertainty, the amount of excess capability is defined probabilistically by a mean ( $\mu_X$ ) and standard deviation ( $\sigma_X$ ). Using the Taylor series approximation mentioned in Section 4.3, we can calculate the variance of the system evolvability based on the variance of excess capability.

#### 4.6 Optimization under uncertainty

This analysis seeks to maximize the benefit of excess capability while minimizing any associated costs. Additionally, the optimization accounts for and mitigates the effects of uncertainty in the model. This is accomplished by shifting the constraints on the design space and by minimizing the propagated variance of the cost and benefit as objectives

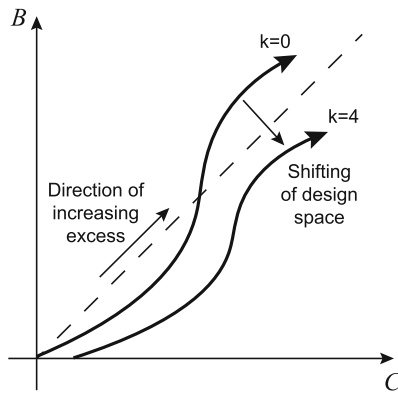

**Fig. 13** Illustration of how uncertainty can shift the design space

in the optimization framework. The formulation of the optimization problem is thus given by

$$\begin{aligned}
 &\underset{\mathbf{X}}{\text{minimize:}} && \text{maximin}(-\bar{B}(\mathbf{X}), \bar{C}(\mathbf{X}), \sigma_B^2(\mathbf{X}), \sigma_C^2(\mathbf{X})) \\
 &\text{subject to:} && \mathbf{X}_{\min} + k\sigma_X \leq \mathbf{X} \leq \mathbf{X}_{\max} - k\sigma_X \\
 & && G_i(\mathbf{X}) \leq p_i - k\sigma_i \\
 & && H_i(\mathbf{X}) = q_i
 \end{aligned} \tag{15}$$

where  $\bar{B}$  and  $\bar{C}$  are the mean benefit and cost,  $\sigma_B^2$  and  $\sigma_C^2$  are the variance of the benefit and cost, and  $k$  is the number of standard deviations of feasibility for the optimized solution set. All inequality constraints ( $G_i$ ) are shifted by  $k$  standard deviations away from the original constraint bound. Equality constraints ( $H_i$ ) are particularly difficult to manage under uncertainty. Messac and Mattson (2003) suggest that some equality constraints must be strictly satisfied even under uncertainty, while others may be changed into inequality constraints with an allowable margin.

Due to the shift in constraints, the outer edges of the design space are attenuated. This causes the optimal solution curve to shift, as illustrated generally in Fig. 13.

This change in the design space has important implications for planning for evolvability. It means that a given amount of excess capability will often have less benefit toward evolution than is calculated without considering uncertainty.

In Section 5, we demonstrate the methods discussed for optimization under uncertainty ( $k \neq 0$ ) on the design of a military ground vehicle. The results are compared to the same model optimized based on deterministic parameters and requirements ( $k = 0$ ).

### 5 Example (non-deterministic): military ground vehicles

To demonstrate the methods discussed in the previous section, we reconsider the military ground vehicle introduced in Section 3.

**Table 7** Minimum and maximum bound (same as Table 1) and the standard deviation for each type of excess capability in the military ground vehicle

Type of Excess	$X_{\min}$	$X_{\max}$	$\sigma_X$
Excess length ( $X_L$ )	1.00 m	4.00 m	0.05 m
Excess width ( $X_W$ )	2.00 m	4.00 m	0.05 m
Excess height ( $X_H$ )	1.25 m	2.50 m	0.05 m
Excess payload ( $X_S$ )	0 kg	3000 kg	250 kg
Excess power ( $X_P$ )	0 kW	400 kW	10 kW

To illustrate the effects of uncertainty, the amount of excess capability in the system is assumed to have a normal distribution with a known standard deviation. This is a typical form of aleatory uncertainty found in manufacturing parameters. The standard deviation of each design variable in this example is also given in Table 7.

For the current analysis, we assume that the designers have specified a minimum feasibility of 99.99 % for any generated designs. This corresponds with a shift of 4 standard deviations from the mean. Therefore, we will shift each constraint by  $4\sigma$ .

#### 5.1 Probabilistically defined requirements

In the current example, we assume that the same four future requirements introduced in Section 3.2 exist; the requirement to become (i) an armored transport vehicle, (ii) a telecommunications vehicle, (iii) a vehicle to launch UAVs, and (iv) a vehicle to support currently unknown medical-related technology. In the current example, each of these requirements is defined by a probability distribution. Table 8 outlines the probability that each future requirement will occur, based on a 20 year service life. If the service life is more or less than 20 years, the probability of occurrence changes as demonstrated in Fig. 12.

#### 5.2 Uncertain benefit and cost per unit excess

The benefit of excess for this non-deterministic example is the same as that presented in Section 3 (deterministic example). The benefit with respect to each future requirement

**Table 8** Probabilities of potential future states to which the vehicle might need to evolve

Potential evolutions	Probability mean	Probability Std. Dev.
Armored transport vehicle	0.95	0.05
Communication vehicle	0.80	0.10
UAV launch vehicle	0.40	0.10
New medical tech vehicle	0.20	0.15

is, however, scaled by the probability of that requirement occurring over time. The benefit ( $b_i$ ) terms are provided in Table 3.

The costs are not affected by the probability of future events. However, the net present value of all cash flows is affected by the service life. The costs of excess capability for the current analysis are given in Table 4.

### 5.3 Non-deterministic optimization formulation

The uncertainties discussed above are used in the optimization, such that the problem formulation is given by

$$\begin{aligned}
 & \underset{X}{\text{minimize}} && \text{maximin}(-B(X), C(X), \sigma_B(X), \sigma_C(X)) \\
 & \text{subject to} && (1.00 + k\sigma_{X_L}) \leq X_L \leq (4.00 - k\sigma_{X_L}) \\
 & && (2.00 + k\sigma_{X_W}) \leq X_W \leq (4.00 - k\sigma_{X_W}) \\
 & && (1.25 + k\sigma_{X_H}) \leq X_H \leq (2.50 - k\sigma_{X_H}) \\
 & && (0.00 + k\sigma_{X_S}) \leq X_S \leq (3000.00 - k\sigma_{X_S}) \\
 & && (0.00 + k\sigma_{X_P}) \leq X_P \leq (400.00 - k\sigma_{X_P}) \\
 & && (0.60 + k\sigma_{X_{SSF}}) \leq SSF
 \end{aligned}
 \tag{16}$$

where  $X = \{X_L, X_W, X_H, X_S, X_P\}$ , and where  $X_L, X_W$ , and  $X_H$  have units of meters,  $X_S$  has units of kilograms, and  $X_P$  has units of kilowatts. The minimum and maximum bounds for each type of excess capability form the

primary inequality constraints. A final inequality constraint ensures that the static stability factor (SSF) remains above 0.60 as defined by (10). Each constraint is shifted based on the propagated variances.

### 5.4 Non-deterministic optimization results and discussion

The model is simulated using a 5 % interest rate and a 20 year service life. The constraints are shifted by four standard deviations in the uncertain case, and by zero standard deviations in the benchmark deterministic case. Figure 14 shows the Pareto front of the analysis under uncertainty (red) plotted with the deterministic analysis (green).

Figure 14a shows a shifting of the Pareto front at the outer extremities. A dramatic shift can also be seen in Fig. 14b, showing that the optimal amount of evolvability with the highest value return is less than previously thought. When the points are sampled, it can be seen that the shift and attenuation are due to the change in inequality constraints, all of which are binding at the extremities of the plot.

This solution set can be used to select the amount of excess capability that should be included, based on the budget that the stakeholders are willing to allocate towards improving the evolvability of the system. It should be noted that the minimum budget that will turn a net positive value

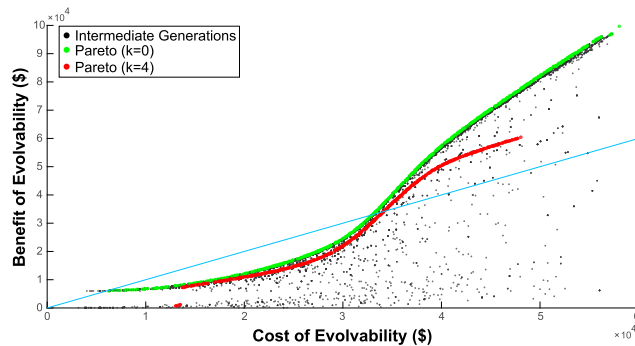

(a) Cost vs. Benefit: 20 Year Life

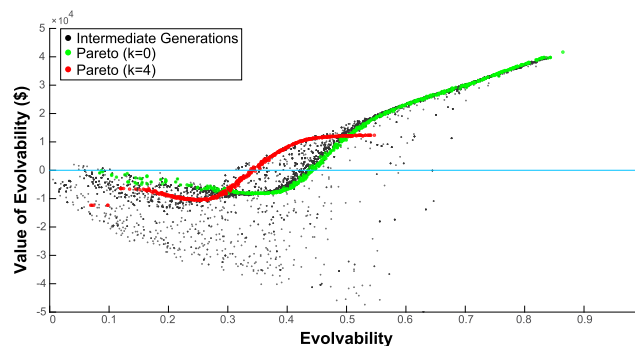

(b) Evolvability vs. Value: 20 Year Life

**Fig. 14** Preliminary generations and final solution set for military ground vehicle with a 20 year service life

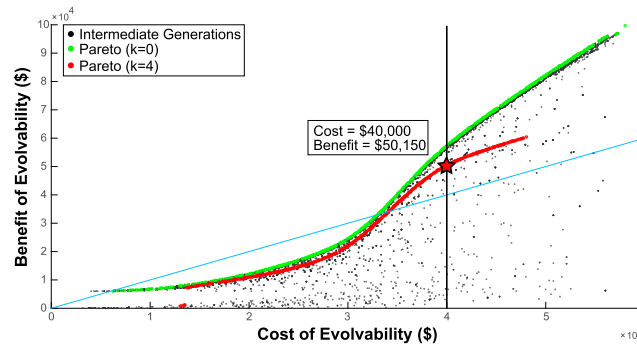

**Fig. 15** Optimal solution for a military ground vehicle with a 20 year service life and a \$40,000 budget constraint

for excess added is higher for the non-deterministic case than for the deterministic case (although only slightly for this 20 year case). Figure 15 shows that for a budget of \$40,000 the value calculated with consideration for uncertainty is significantly less than the value calculated without uncertainty (the deterministic case was shown in Fig. 9).

The optimal solutions for three different budget constraints, as defined by the deterministic analysis ( $k = 0$ ), are listed in Table 6, and the optimal solutions for the same three budget constraints, as defined by the non-deterministic analysis ( $k = 4$ ), are listed in Table 9. As can be seen in this table, no solutions exist in the \$50,000–\$60,000 range. This is due to the increased limitation on the amount of excess capability that can be added, due to shifting inequality constraints.

The value calculated under uncertainty for a budget of \$40,000 is nearly 40 % less than the value predicted for the same budget in the deterministic solution. The value of excess for a budget of \$50,000 is 60 % less than the value predicted for the same budget in the deterministic solution. However, the greatest divergence is seen after the benefits begin to outweigh the costs of excess. Beyond this “break-even” point, the deterministic analysis shows a steady growth in the net value of excess capability.

However, the non-deterministic analysis reveals a trend toward decreasing value with increased excess capability beyond this point. This shows how optimizing without consideration for uncertainty can yield misleading results.

**5.5 Final design selection based on non-deterministic evaluation**

Figure 14 demonstrates the wide range of possible optimal solutions with varying evolvability and value. In order to select a single optimal design, designers use selection criteria. In this example, the selection criteria is chosen to be the budget allocated for improving system evolvability, which is taken to be \$50,000. From Table 9 we find that the system that will yield the highest value, with 99.99 % feasibility and a service life of 20 years, is the system shown in Fig. 16.

**Table 9** Highest value configuration for different budget constraints under uncertainty ( $k = 4$ )

	\$40,000 Budget	\$50,000 Budget	\$60,000 Budget
$X_L$	3.71 m	3.71 m	N/A
$X_W$	3.78 m	3.79 m	N/A
$X_H$	1.87 m	1.87 m	N/A
$X_S$	1,984 kg	1,986 kg	N/A
$X_P$	254.55 kW	351.39 kW	N/A
Cost	\$39,823	\$48,046	N/A
Benefit	\$50,149	\$60,440	N/A
Value	\$10,325	\$12,394	N/A
Evolv.	0.42	0.55	N/A

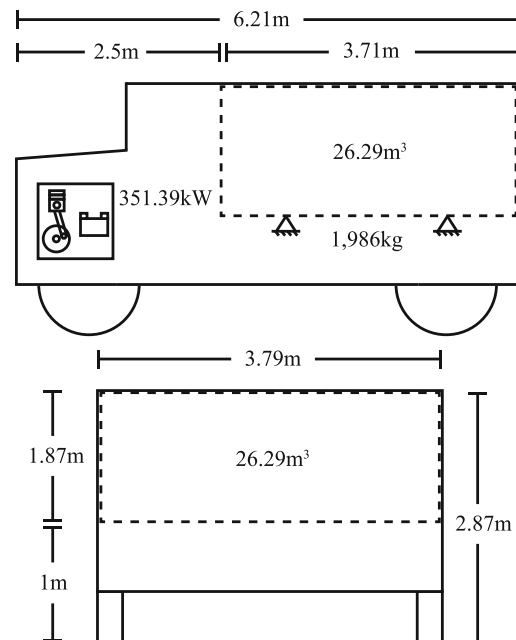

**Fig. 16** Simple representation of the final design for a military ground vehicle (under uncertainty) with a 20 year service life and a \$50,000 budget constraint

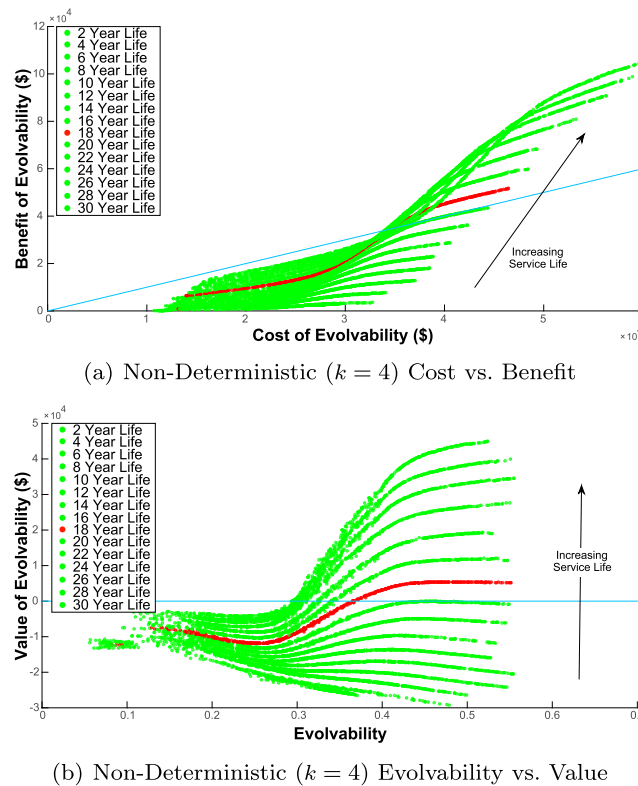

**Fig. 17** Minimum service life to create a net positive value of excess capability under uncertainty ( $k = 4$ )

## 5.6 Expected service life

As has been mentioned, the optimal solution set is dependent on the expected service life of the system. In Fig. 11, we plot the optimal cost-benefit and value-evolvability curves from the deterministic analysis ( $k = 0$ ) for 15 different service life expectations. Figure 17, shows these same curves for the non-deterministic analysis ( $k = 4$ ). These plots show that, under uncertainty, there is an increase in the minimum service life (from 14 to 18 years) required for excess capability to be profitable. We also note that, under uncertainty, the maximum value of excess capability is considerably decreased for a given service life, at times by a factor of two.

Most importantly, including uncertainty in our analysis has shown that there is a limit to the value that can be added by excess capability. The deterministic analysis showed continually increasing value after the point of equal cost and benefit. In contrast to this, the non-deterministic analysis revealed that the value peaks and then declines with additional excess capability. In the absence of other constraints, it is this optimal peak point that will return the highest value from excess capability, not the maximum allowable amount of excess.

## 6 Conclusion

Complex systems can benefit from added excess capability that can be used to evolve towards emerging requirements. In-service evolution is critical to many complex systems, where long system life can lead to premature obsolescence, unless the system can be evolved. Following the framework introduced in this paper, designers can optimize the amount of excess built into complex systems. Optimized systems will be better able to meet future requirements without adding excessive cost.

From a deterministic point-of-view, the example in Section 3 illustrates the effectiveness of the proposed framework in facilitating decision making for complex systems. Importantly, it shows that consideration for value must be included when designing for system evolvability. When the same problem is optimized without consideration of value, the results tend toward maximization of excess capability, regardless of the costs and benefits associated with fulfilling certain future requirements, as was the case with Tackett et al. (2014). When the problem is optimized with the framework presented herein, the solution decreases the amount of excess assigned to future requirements that are more costly or provide less benefit to the system.



A key element of the described process is identifying and accurately modeling the impact of potential future requirements. Complex systems designers must carefully select functions for cost and benefit that accurately represent the value trade-off in their situation. With and without the consideration of uncertainty, the analysis revealed several important characteristics of evolvable systems and excess capability. Because evolvability is an inherently uncertain attribute, it is sensitive to uncertain input parameters. As such we include the effects of uncertainty in the optimization of evolvability to avoid misleading results. As illustrated by the military ground vehicle example, propagating the uncertainty of model input parameters gives a more realistic depiction of the design space, and allow designers to measure the benefits of excess capability in the presence of uncertainty.

**Acknowledgments** The authors would like to recognize the National Science Foundation Grant CMMI-1301247 for funding this research. Any opinions, findings, and conclusions or recommendations expressed in this material are those of the authors and do not necessarily reflect the views of the National Science Foundation.

## References

- Allen JD, Watson JD, Mattson CA, Ferguson SM (2014) Assessment of system reconfigurability based on usable excess. In: Proceeding of the ASME 2014 International Design Engineering Technical Conferences and Computers and Information in Engineering Conference
- Anderson TV, Mattson CA (2012) Propagating skewness and kurtosis through engineering models for low-cost, meaningful, nondeterministic design. *J Mech Des* 134(10):100,911
- Arendt JL, McAdams DA, Malak RJ (2012) Uncertain technology evolution and decision making in design. *J Mech Des* 134(10):100,904
- Ayyub BM, Klir GJ (2006) *Uncertainty Modeling and Analysis in Engineering and the Sciences*. Chapman & Hall/CRC
- Balling R (2003) The maximin fitness function; multi-objective city and regional planning. In: Fonseca C, Fleming P, Zitzler E, Thiele L, Deb K (eds) *Evolutionary Multi-Criterion Optimization*, Lecture Notes in Computer Science, vol 2632, Springer Berlin Heidelberg, pp 1–15
- Bartolomei JE, Hastings DE, de Neufville R, Rhodes DH (2012) Engineering systems multiple-domain matrix: An organizing framework for modeling large-scale complex systems. *Syst Eng* 15(1):41–61
- Bloebaum CL, McGowan AR (2012) The design of large-scale complex engineered systems: present challenges and future promise. In: Proceedings of the 14th AIAA/ISSMO Multidisciplinary Analysis and Optimization Conference, Indianapolis, IN, Paper No. AIAA-2012–5571
- Bloebaum CL, Collopy PD, Hazelrigg GA (2012) NSF/NASA workshop on the design of large-scale complex engineered systems—from research to product realization. In: Proceedings of the 14th AIAA/ISSMO Multidisciplinary Analysis and Optimization Conference, Indianapolis, IN, Paper No. AIAA-2012–5572
- Bonissone PP, Varma A, Aggour K (2005) A fuzzy instance-based model for predicting life: a locomotive application. In: CIMS 2005 - IEEE International Conference on Computational Intelligence for Measurement Systems and Applications, IEEE
- Cardin MA, Nuttall WJ, Neufville RD, Dahlgren J (2007) Extracting value from uncertainty: A methodology for engineering systems design. In: 17th Symposium of the International Council on Systems Engineering, San Diego, CA
- Clarkson JP, Simmons C, Eckert C (2004) Predicting change propagation in complex design. *J Mech Des* 126:778–797
- Engelbrecht AP (2007) *Computational Intelligence: An Introduction*, 2nd edn. John Wiley and Sons
- English K, Bloebaum C, Miller E (2001) Development of multiple cycle coupling suspension in the optimization of complex systems. *Struct Multidiscip Optim* 22:268–283
- Ferguson S, Siddiqi A, Lewis K, de Weck O (2007) Flexible and reconfigurable systems: Nomenclature and review. In: Proceeding of IDETC/CIE
- Ferguson SM, Lewis K (2006) Effective development of reconfigurable systems using linear state-feedback control. *AIAA J* 44(4):868–878
- Frischknecht BD, Peters DL, Papalambros PY (2011) Pareto set analysis: local measures of objective coupling in multiobjective design optimization. *Struct Multidiscip Optim* 43:617–630
- Greitzer FL, Ferryman TA (2001) Predicting remaining life of mechanical systems. In: *Intelligent Ship Symposium IV*, 2–3
- Hoffenson S, Kokkolaras M, Papalambros P, Arepally S (2011) Ground vehicle safety optimization considering blastworthiness and the risks of high weight and fuel consumption. Tech. rep., US Army, Mechanical Engineering University of Michigan Ann Arbor
- Keese DA, Takawale NP, Seepersand CC, Wood KL (2006) An enhanced change modes and effects analysis (cmea) tool for measuring product flexibility with application to consumer products. In: Proceedings of IDETC/CIE
- Lamb CJ, Schmidt MJ, Fitzsimmons BG (2009) Mraps, irregular warfare and pentagon reform. Tech. rep., National Defense University, Institute for National Strategic Studies
- Lewis KE, Collopy PD (2012) The role of engineering design in large-scale complex systems. In: 12th AIAA Aviation Technology, Integration, and Operations (ATIO) Conference and 14th AIAA/ISSMO
- Lewis PK, Mattson CA (2013) An optimization-based method for designing modular systems that traverse dynamic s-pareto frontiers. *Struct Multidiscip Optim* 48:747–762
- Madni AM, Epstein DJ (2011) *Adaptable Platform-Based Engineering: Key Enablers and Outlook for the Future*, Systems Engineering, vol 15. Wiley Online Library
- Marler RT, Arora JS (2004) Survey of multi-objective optimization methods for engineering. *Struct Multidiscip Optim* 26:369–395
- Messac A, Mattson CA (2003) Handling equality constraints in robust design optimization. In: 44th AIAA/ASME/ASCE/AHS Structures, Structural Dynamics, and Materials Conference, AIAA-2003-1780
- Pandey V, Mourelatos ZP (2014) Rules for trajectory updating in decision based design. *Struct Multidiscip Optim* 49:49–57
- Parkinson A, Sorensen C, Pourhassan N (1993) A general approach for robust optimal design. *J Mech Des* 115(1):74–80
- Sandborn PA, Herald JTE, Houston J (2003) Optimum technology insertion into systems based on the assessment of viability. In: *IEEE Transactions on Computer Aided Design of Integrated Circuits and Systems*, vol 26, pp 734–738
- Siddiqi A, de Weck O (2008) Modeling methods and conceptual design principles for reconfigurable systems. *Journal of Mechanical Design* 130
- Simpson TW, Martins JRR (2011) *Multidisciplinary design optimization for complex engineered systems: Report from a national*

- science foundation workshop. In: *Journal of Mechanical Design* vol 133, pp 101, 002–1
- Sosa ME, Eppinger SD, Rowles CM (2007) A network approach to define modularity of components in complex products. *J Mech Des*:129
- Tackett MW, Mattson CA, Ferguson SM (2014) A model for quantifying system evolvability based on excess and capacity. *J Mech Des* 136(5):051,002
- Tao R (2011) *Electro-rheological Fluids and Magneto-rheological Suspensions* : Proceedings of the 12th International Conference. World Scientific, Singapore
- Tilstra AH, Seepersand CC, Wood KL (2009) Analysis of product flexibility for future evolution based on design guidelines and a high-definition design structure matrix. In: *Proceeding of the ASME 2009 International Design Engineering Technical Conferences and Computers and Information in Engineering Conference*
- Ulrich K (1995) The role of product architecture in the manufacturing firm. *Res Policy* 24:419–440
- VanBeek TJ, Tomiyama T (2012) Structured workflow approach to support evolvability. *Adv Eng Inform* 26:487–501
- Walz MC (2005) Trends in the static stability factor of passenger cars, light trucks, and vans. Tech. rep., US DOT, National Highway Traffic Safety Administration
- Weiner SK (2010) Organizational interests versus battlefield needs: The u.s. military and mine-resistant ambush protected vehicles in iraq. *Polity* 42(4):461–482
- Yap CHK (2012) The impact of armor on the design, utilization and survivability of ground vehicles. the history of armor development and use. Master's thesis, Naval Postgraduate School, September
- Zhou J, Cheng S, Li M (2012) Sequential quadratic programming for robust optimization with interval uncertainty. *Journal of Mechanical Design*